



ICT DC DISTRIBUTION PANEL

ICT180-12IRC INTELLIGENT MODEL
WITH REMOTE POWER CONTROL



INSTRUCTION MANUAL

INNOVATIVE CIRCUIT TECHNOLOGY LTD.

855-313-402

TABLE OF CONTENTS

Warnings	Page 2
Product Description	Page 3
Installation	Page 4
LCD/Select Button Operation	Page 6
Web–Based Configuration Utility	Page 8
Status	Page 9
Basic Setup	Page 10
Network Setup	Page 12
Alarm Setup	Page 13
User Setup	Page 15
Maintenance	Page 15
Password Reset	Page 16
Router Configuration	Page 16
Text Message Alarm Notifications	Page 19
Troubleshooting	Page 20
Product Specifications	Page 21
Limited Warranty	Page 22

WARNINGS

To reduce the risk of personal injury and property damage, please exercise caution and follow the warnings below.

- ▶ No user serviceable parts inside. Only ICT personnel are authorized to service the unit.

- ▶ Keep sources of moisture away from the unit.

- ▶ Read manual completely before starting installation or operation of unit. Manual should be saved for future reference.

- ▶ Observe correct polarities when making the input and output connections.

- ▶ Securely tighten all connections and insert fuses fully. Refer to product specifications for maximum torque for the connectors.

- ▶ Use appropriate wire size for both input and output connections.

- ▶ Connect chassis of the unit to an Earth ground point.

- ▶ Turn off power source before installing/removing fuses, connecting/disconnecting loads, or connecting/disconnecting power source.

- ▶ Allow input insulated studs and fuses to cool off before handling. Depending on the current flowing through them, they may be too hot to touch.

- ▶ Do not connect any power source to the output terminal blocks. Doing so may cause the fuse status LEDs and alarm to not work properly.

- ▶ It is recommended that the power source be equipped with current limit protection.

PRODUCT DESCRIPTION

The **ICT180–12IRC** Intelligent Distribution Panel with Remote Power Control is designed for either 12 or 24VDC applications. It provides 12 output positions that are individually protected by blade type fuses. Nine of the outputs use the ATO/ATC blade fuse that are rated up to 25A each. Three of the outputs use the MAXI blade fuse and are rated up to 40A each. These fuses are located on the front of the panel for easy monitoring and replacement. Each positive output terminal point is connected through a fuse to a positive internal bus. All negative output terminal points are connected to a negative internal bus.

System voltage, system current, output currents and fuse status can be monitored onsite through the LCD graphics display. Fuse status is also displayed by an LED indicator. Form “C” alarm contacts (C/NO/NC) are provided on the back of the panel for an external alarm circuit.

Remote monitoring is available through the integrated security protected Ethernet communications port on the back of the panel. The panel has a built-in web server with an embedded web-based GUI that can be accessed using any standard commercial web browser such as Internet Explorer. The web server not only displays panel information, it can also be set up to send an alarm to a user-defined email account in the event a fault occurs. The web server can also be for data logging of up to 30 hours of event information. All these features are packaged in a 1RU enclosure to save valuable rack space, with a 19” wide front plate to fit standard 19” equipment racks.

DC outputs can be turned on and off remotely, allowing connected loads to be power-cycled through the Ethernet connection.

FRONT PANEL

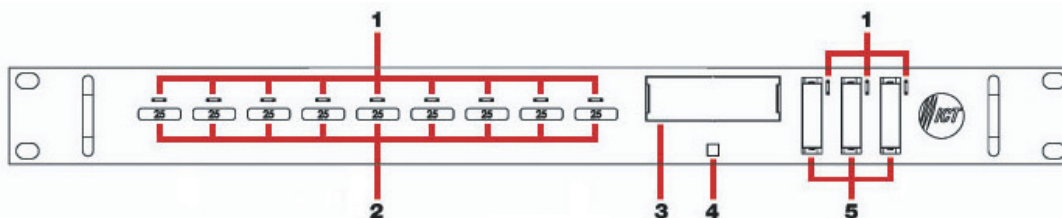

Figure 1.

1. FUSE STATUS LEDs: Turns on when a fuse is blown or missing.
2. ATO/ATC FUSES: Location of the ATO/ATC fuses rated up to 25A.
3. LCD: Displays system voltage, system current, output current and fuse status for each of the 12 output positions.
4. SELECT BUTTON: For switching between LCD screens, and resetting network, web server and password settings to original factory default values.
5. MAXI FUSES: Location of the MAXI fuses rated up to 40A.

BACK PANEL

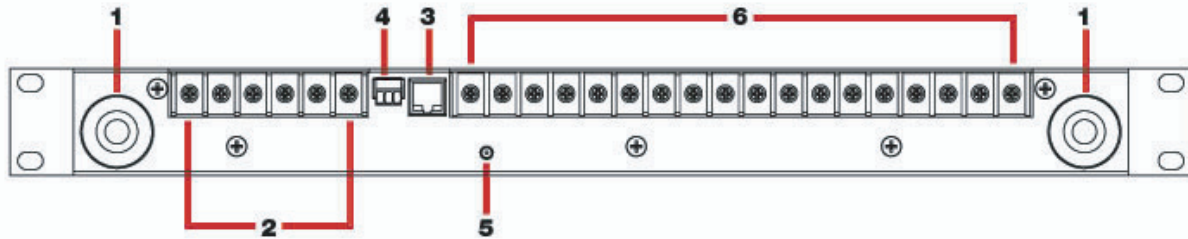

Figure 2.

1. INPUT STUDS: For DC power source connection up to 180A peak and 150A continuous.
2. OUTPUT TERMINAL BLOCK 10 – 12: For DC load connections up to 40A each pair.
3. LAN PORT: For remote monitoring via TCP/IP network.
4. ALARM CONNECTOR: For external alarm circuit to monitor unit fault.
5. CHASSIS GROUND STUD: For Earth ground connection.
6. OUTPUT TERMINAL BLOCK 1 – 9: For DC load connections up to 25A each pair.

INSTALLATION

1. Inspect panel and accessories to make sure everything is complete and in good condition.
2. For rack set up, install panel on the rack using appropriate size screws and star washers on all four mounting holes. If equipment rack is not electrically connected to Earth ground, connect a ground cable from the ground stud on the back of the panel to a known Earth ground point. Otherwise, the four mounting screws and washers may be sufficient for earth ground connection.

OR

For non–rack set up, connect a ground cable from the ground stud on the back of the panel to a known Earth ground point.

3. Remove the plastic shield(s) covering the output terminal block(s) located on the back of the panel. Connect the positive of the load to the positive terminal point (labeled “+”) and the negative of the load to the negative terminal point (labeled “–”).

4. Install fuse on the front of the panel for each output terminal block. The fuse number on the front of the panel matches the output terminal block number on the back of the panel. Consult your local electrical codes for wire ampacity and fuse sizing. Typically, fuses and wiring are derated to 80% of their rating (e.g. 12 Amps for a 15 Amp fuse). For terminal blocks with no load connected, insert any size fuse to prevent the LED on the front of the panel from turning on and the alarm from activating if the form “C” alarm is used.
5. Remove the plastic caps covering the input insulated studs. Connect the positive of the power source to the red insulated stud (labeled “+”) and the negative of the power source to the black insulated stud (labeled “-”).
6. Re-install plastic shield(s) to the output terminal block(s) and plastic caps to the input studs.
7. For form “C” alarm monitoring, connect an external alarm circuit to the alarm connector located on the back of the panel. Depending on the alarm circuit (refer to table 2), connect it between normally open (NO) and common (C), between normally close (NC) and common (C), or both. The built-in web server controls this alarm. The alarm connector can be unplugged from the panel for easy installation.
8. For remote monitoring and power control, connect your network interface to the Ethernet port on the back of the panel. The recommended cable for Ethernet connection is Cat5e UTP network cable.
9. Power up the distribution panel, and check for proper operation of the connected load(s), fuse status LEDs, LCD, form “C” alarm (if using) and Ethernet communications (if connected).

LED	FUSE STATUS
ON	Blown or missing
OFF	Good

Table 1: Fuse Status LED

NC/C PINS	NO/C PINS	CONDITION
Open	Closed	Fuse Alarm <ul style="list-style-type: none"> • Activate Alarm Form C Contact is checked • One or more blown or missing fuse
		System Under – Voltage Alarm <ul style="list-style-type: none"> • Activate Alarm Form C Contact is checked • System Voltage is below the set value
		System Over – Voltage Alarm <ul style="list-style-type: none"> • Activate Alarm Form C Contact is checked • System voltage is above the set value
		System Over – Current Alarm <ul style="list-style-type: none"> • Activate Alarm Form C Contact is checked • System current is above the set value
		No power to unit
Closed	Open	Activate Alarm Form C Contact is checked and no fault occurred
		All Activate Alarm Form C Contact is not checked

Table 2: Form “C” Alarm

LCD/SELECT BUTTON OPERATION

At power up, the LCD of the panel will display the main screen. To switch between the various LCD screens, press the **Output Select** button on the front of the panel (see Figure 3 for screen order).

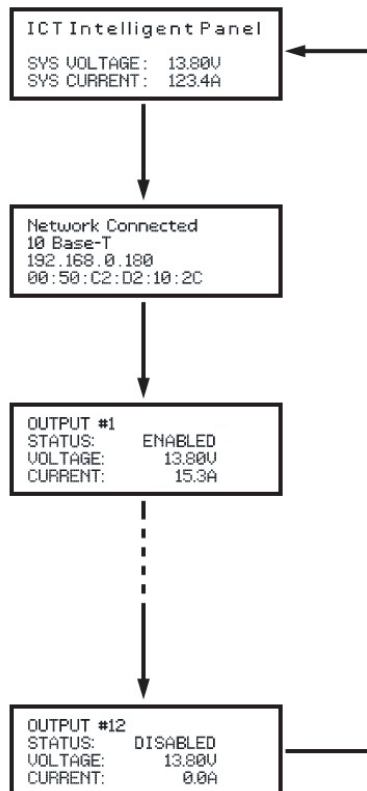

Figure 3: LCD Screens

Holding the **Output Select** button for 2 seconds at any screens will return you to the main screen.

Holding the **Output Select** button for 20 seconds at any screens will reset the password (see **Password Reset** section).

The backlight of the LCD turns off if the **Output Select** button is not pressed for 15 minutes. Press the **Output Select** button to turn the backlight back on.

MAIN SCREEN

Line 1: Displays the name of the panel, which is customizable through the web-based configuration utility.

Line 2: blank

Line 3: Displays the system voltage. Voltage display will blink if the system voltage exceeds the Under-Voltage or Over-Voltage Thresholds set on the **Alarm Setup** page.

Line 4: Displays the system current. Current display will blink if the system current exceeds the Over-Current Threshold set on the **Alarm Setup** page.

NETWORK SCREEN

Line 1: Displays the network status.

Line 2: Displays the connection type.

Line 3: Displays the IP address assigned to the panel.

Line 4: Displays the MAC address of the panel.

OUTPUT SCREEN (1 – 12)

Line 1: Displays the name of the load, which is customizable through the web-based configuration utility.

Line 2: Displays the output status. **ENABLED** for output enabled, **DISABLED** for output disabled, and **FUSE OPEN** for blown or missing fuse.

Line 3: Displays the output voltage. Voltage display will blink if the voltage exceeds the Under-Voltage or Over-Voltage Thresholds set on the **Alarm Setup** page.

Line 4: Displays the output current for that individual output.

WEB-BASED CONFIGURATION UTILITY

Follow these steps to access the panel from a browser. The recommended web browsers to use with this panel are Microsoft Internet Explorer, Mozilla Firefox or Google Chrome.

1. Start your web browser.
2. Enter the IP address of the panel in the location/address field of the browser.

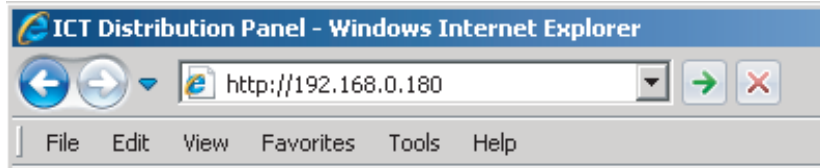

Figure 4.

If the panel is connected to a network with a DHCP server, the panel will be assigned an IP address automatically. To find the current IP address of the panel, see **LCD Operation** section. If the panel is not connected to a network with DHCP, it will use a default IP address of **192.168.0.180**.

3. Enter your user name and password. The default Administrator user name is **admin**, and there is no password by default.

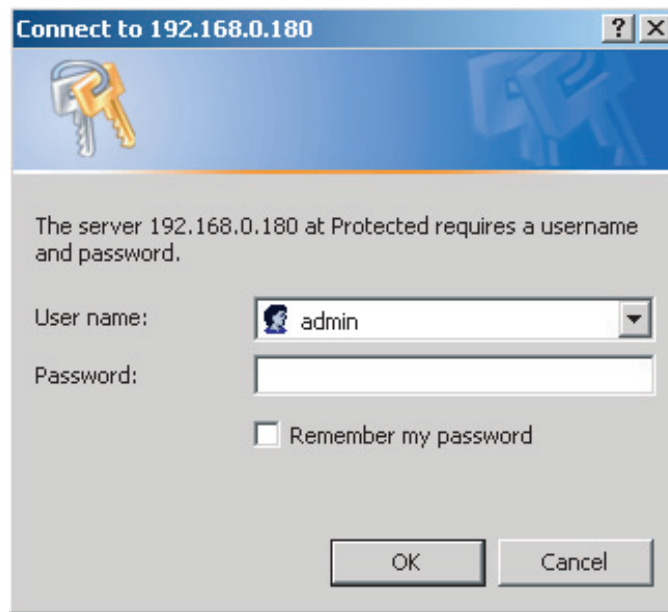

Figure 5.

4. Once connected, the panel **Status & Control** page will appear in your browser window.

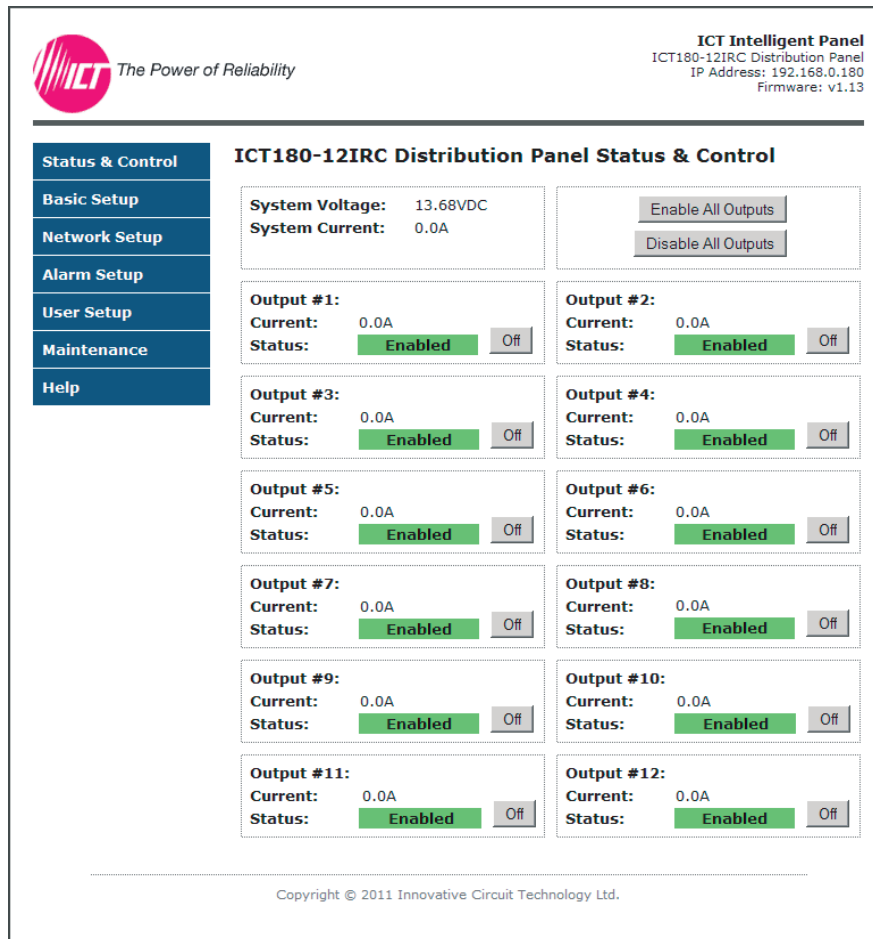

Figure 6.

STATUS & CONTROL

This page provides information on system voltage, system current, output status, and current level by output contact (1 through 12). It also allows you to manually enable or disable DC power to the each of the output terminals.

When viewing this page through a standard HTTP connection, the on–screen display will continuously refresh automatically. When viewing this page through an encrypted HTTPS connection, you will need to refresh the on–screen display manually by clicking on the **Status & Control** menu button or refreshing your browser.

Enable All Outputs: Pressing this button will enable DC power to all outputs. If power–on sequencing is enabled on the Basic Setup page, the outputs will be enabled in sequence, instead of enabling them simultaneously.

Disable All Outputs: Pressing this button will disable DC power to all outputs.

On and Off: Pressing these buttons will enable or disable DC power to individual outputs.

BASIC SETUP

This page allows you to configure the basic settings of the panel. To save any changes to the basic settings, click on **Save Settings** at the bottom of this page.

PANEL INFO

Site Name: Allows you to assign a custom name to the panel.

Model: Displays the model number of the panel.

OUTPUTS

Label: Allows you to assign a custom name to each individual output. The output names are displayed on the **Status & Control** page, as well as on the LCD screen.

Load-Shedding: Allows you to turn on load-shedding for each individual output. Load-shedding automatically disables DC power to the output when the panel's system under-voltage alarm is triggered. The under-voltage threshold is set on the **Alarm Setup** page.

The panel must remain in an under-voltage condition for at least 30 seconds before the output will be disabled. This is to prevent the outputs from being disabled prematurely during a power surge.

Load-Shedding Auto Recovery: If this box is checked, outputs that have load-shedding turned on will automatically be enabled after panel's system under-voltage alarm is cleared. The system under-voltage alarm must remain cleared for at least 60 seconds before the outputs will be enabled. If this box is unchecked, outputs will need to be manually re-enabled after load-shedding is triggered.

Send Load-Shedding E-mail: If this box is checked, an e-mail alarm notification will be sent when outputs are automatically enabled or disabled by the load-shedding setting. The e-mail settings on the **Network Setup** page must be configured correctly before e-mail notifications can be sent.

Power Cycle: Allows you to turn on power-cycling for each individual output. When Power-Cycling is enabled for an output, the output will automatically be re-enabled after a selectable period of time after it is disabled from the **Status & Control** page. Power-Cycling is useful for remotely resetting power to hardware that is needed for network connectivity to the panel.

The **Sequence / Cycle Delay** field controls the period of time that the output remains disabled before it is re-enabled. The Power Cycle setting will have no effect if no time delay is entered in the **Sequence / Cycle Delay** field.

If multiple outputs with Power-Cycling enabled are disabled from the **Status & Control** page at the same time, they will be re-enabled in sequence.

POWER-ON SEQUENCING / CYCLING

Sequence / Cycle Delay: Entering a time delay in this field will cause all outputs to be enabled in sequence when the **Enable All Outputs** button is pressed on the **Status & Control** page, rather than enabling all outputs simultaneously. This delay helps prevent power surges that can occur when too many devices are turned on at the same time. The time delay before each output is enabled can be set to a value between 0 and 60 seconds. If the Power Cycle option is enabled for any outputs, this field also sets the Power Cycle time delay.

Reverse Sequence Order: If this box is checked, the outputs will be enabled in reverse sequence (Output #12 first, Output #1 last) when the **Enable All Outputs** button is pressed on the **Status & Control** page.

NETWORK WATCHDOG

Watchdog Enabled: Checking this box will enable the Network Watchdog feature. The Network Watchdog will periodically Ping a remote IP address to check the network connection status. If the remote IP address stops responding, the Panel will power-cycle any outputs that have the **Power Cycle** option enabled. This feature is useful for rebooting a modem or router following a crash that has resulted in loss of IP connectivity. For the Network Watchdog to work, at least one output must have the **Power Cycle** option enabled, and a time delay must be entered in the **Sequence / Cycle Delay** field.

IP Address: Enter the remote IP address you would like to monitor. This field is optional; if left blank, the Network Watchdog will instead monitor the Gateway IP address listed on the **Network Setup** page.

Watchdog Timeout: Enter the time duration, in minutes, that the remote IP address must stop responding to Ping requests before the Network Watchdog will trigger and power-cycle outputs. The default setting is 10 minutes. The Watchdog Timeout can be changed to anything between 1 and 80 minutes. Make sure that the Watchdog Timeout value is set longer than the time it takes for your network hardware to fully start up.

Send Watchdog E-mails: If this box is checked, an e-mail notification will be sent after the Network Watchdog triggers and the network connection has come back online. The e-mail settings on the **Network Setup** page must be configured correctly before e-mail notifications can be sent.

DATA LOGGING

Data Logging: Allows you to enable data logging. With data logging enabled, the panel will record the system voltage, system current, output currents, and fuse status at a sample rate of 1 sample per minute. To view the log while data logging is enabled, click on the **Download Log button** next to the data logging dialog box. This will download the log in Comma Separated Values (CSV) format, which can be opened by most spreadsheet software applications such as Microsoft Excel. The log will hold up to 30 hours of data, with oldest log entries at the top of the log file.

NETWORK SETUP

WARNING: Changing the network settings will reboot the panel. All outputs will be enabled after the reboot is complete.

This page allows you to configure the network settings of the panel. To save any changes to the network settings, click on **Save Settings** at the bottom of this page and panel will reboot.

NETWORK

MAC Address: Displays the MAC address assigned to the panel. It can also be found on line 4 of the network status screen of the LCD (see **LCD/Select Button Operation**).

Enable DHCP: Turn on this setting if your network is using a DHCP server to automatically assign IP addresses (DHCP is enabled by default). To manually assign a Static IP address to the panel, uncheck the **Enable DHCP** box and then set the following settings.

IP Address: Specify a unique IP address for the panel.

Subnet Mask: Specify the mask for the subnet the panel is located on.

Gateway: Specify the IP address of the default router (gateway) used for connecting attached devices to different networks.

Primary DNS: Specify the IP address of the Primary DNS Server for your network.

Secondary DNS: Specify the IP address of the Secondary DNS Server for your network.

WEB SERVER

WARNING: Changing these ports may affect your ability to access the panel.

The web server port numbers can be changed to any port within the range 1 – 65565.

HTTP Port: Allows you to change the HTTP port number. This port is used for HTTP traffic between the panel and web browser. The default HTTP port is **80**. If you change the HTTP port to a number besides 80, you will have to append the new port number to the URL used to access the panel (e.g.

http://192.168.0.180:8000 for IP address **192.168.0.180**, port **8000**).

HTTPS Port: Allows you to change the HTTPS port number used by the panel. HTTPS (HTTP secure) is a protocol which encrypts data transferred between web browsers and servers. The default HTTPS port is **443**.

To access the panel through a secure HTTPS connection, type **https://** in front of the URL used to access the panel (e.g. **https://192.168.0.180:8888** for IP address **192.168.0.180**, HTTPS port **8888**).

UDP Port: Allows you to change the UDP port number used by the panel. This port is used when applying firmware upgrades to the panel. The default UDP port is **9393**.

E-MAIL

Configure these settings if you would like to receive e-mail alarm notifications from the panel. The information for the following settings is available from your Network Administrator or Internet Service Provider (ISP).

SMTP Server: The name or IP address of your SMTP server used for sending outgoing e-mail.

Note: SSL (Secure Socket Layer) is not supported by the panel e-mail alarm notifications. Some web-based SMTP servers require SSL; the e-mail alarm notifications will not work properly if your server requires SSL.

SMTP Port: The port used by your SMTP server. The standard port used by most SMTP servers is **25**.

"From" E-mail Address: Enter the e-mail address you wish to appear as the sender of the e-mail notifications.

"To" E-mail Address #1: Enter an e-mail address you wish to receive the e-mail notifications. This field can also be used to send a text message notification to a cell phone. See the **Text Message Alarm Notifications** section for more information.

"To" E-mail Address #2: If you would like a second e-mail address to receive the e-mail notifications, enter it here. If this field is used, a valid e-mail address must also be entered in the **"To" E-mail Address #1** field.

SMTP User Name: If your SMTP server requires a user name and password, enter the user name here. Leave this field blank if your SMTP server does not require authentication.

SMTP Password: If your SMTP server requires a user name and password, enter the password here. Leave this field blank if your SMTP server does not require authentication.

Minimum E-mail Interval: This setting allows you to specify how many minutes have to elapse between e-mail notifications. This setting is used to prevent your network from being flooded with alarm e-mails if your alarm thresholds are not set correctly. The default setting is 1 minute. This setting can be changed to anything between 0 and 60 minutes.

ALARM SETUP

This page allows you to select which alarms you wish to monitor, and also allows you to enter custom thresholds for each status condition. To save any changes to the alarm settings, click on **Save Settings** at the bottom of this page.

FUSE ALARM

Activate Alarm Form C Contact: If this box is checked, the alarm form "C" contacts on the panel will indicate a fault condition when an output fuse is blown.

Send E-mail: If this box is checked, an e-mail alarm notification will be sent when an output fuse is blown. The e-mail settings on the **Network Setup** page must be configured correctly before e-mail notifications can be sent.

SYSTEM UNDER-VOLTAGE ALARM

Under-Voltage Threshold: If the system voltage drops below the value in this field, the system under-voltage alarm will trigger.

Under-Voltage Recovery: If the system voltage rises above the value in this field, the system under-voltage alarm will clear. The value in this field must be at least 0.25V higher than the Under-Voltage Threshold.

Note: If **Load-Shedding Auto-Recovery** is enabled on the **Basic Setup** page, be careful not to set the Under-Voltage Threshold and Under-Voltage Recovery values too close together. Depending on your site setup, the system voltage may rise slightly after outputs are disabled. If the system voltage rises above the Under-Voltage Recovery value as soon as the outputs are disabled, the outputs will be re-enabled prematurely.

Activate Alarm Form C Contact: If this box is checked, the Alarm Form “C” Contacts on the panel will indicate a fault condition when the system under-voltage alarm is triggered.

Send E-mail: If this box is checked, an e-mail alarm notification will be sent when the system under-voltage alarm is triggered. The e-mail settings on the **Network Setup** page must be configured correctly before e-mail notifications can be sent.

SYSTEM OVER-VOLTAGE ALARM

Over-Voltage Threshold: If the system voltage rises above the value in this field, the system over-voltage alarm will trigger.

Activate Alarm Form C Contact: If this box is checked, the alarm form “C” contacts on the panel will indicate a fault condition when the system over-voltage alarm is triggered.

Send E-mail: If this box is checked, an e-mail alarm notification will be sent when the system over-voltage alarm is triggered. The e-mail settings on the **Network Setup** page must be configured correctly before e-mail notifications can be sent.

SYSTEM OVER-CURRENT ALARM

Over-Current Threshold: If the total system current rises above the value in this field, the system over-current alarm will trigger.

Activate Alarm Form C Contact: If this box is checked, the alarm form “C” contacts on the panel will indicate a fault condition when the system over-current alarm is triggered.

Send E-mail: If this box is checked, an e-mail alarm notification will be sent when the system over-current alarm is triggered. The e-mail settings on the **Network Setup** page must be configured correctly before e-mail notifications can be sent.

USER SETUP

This page allows you to configure passwords for accessing the panel. To save any password changes, click on **Save Settings** at the bottom of this page.

Both the Administrator and Standard User accounts have no password assigned to them by default. For improved security, it is recommended that you assign passwords to both accounts.

WARNING: Please record your password. If the Administrator password is lost, the panel must be reset to return the password to the default setting. See the Password Reset section for more information.

Select a User to Edit: There are two user accounts with access to the panel:

Administrator (user name: **admin**) – This account has full access to the panel.

Standard User (user name: **user**) – This account has view–only access to the panel. This account cannot be used to enable/disable outputs, or change settings.

New Password: Allows you to change the password for the selected user.

Confirm New Password: When changing a password, you must re–enter the new password here to confirm.

Administrator Password: Enter the current Administrator password here to confirm changes.

MAINTENANCE

This page allows you to reset the panel, restore the panel to factory default settings, and send test e–mail to verify that functionality.

RESET DISTRIBUTION PANEL

Pressing the **Reset** button will reset the panel and enable DC power to the all of the output terminals. All other settings are maintained during the reset.

RESTORE FACTORY DEFAULT SETTINGS

Pressing the **Restore** button will restore **ALL** settings to the original factory default values, including the passwords. If you only want to restore the network settings and passwords, see the **Password Reset** section.

SEND TEST E–MAIL

Pressing the **Send Test E–mail** button will send test e–mail to the specified recipient using the e–mail settings on the **Network Setup** page.

PASSWORD RESET

Resetting the password resets the Administrator password, network and web server settings to the original factory default values. The Standard User password is not affected. To reset, do the following:

1. Press and hold the **Output Select** button on the front of the panel (approximately 20 seconds) until **Resetting** is shown on the LCD.
2. Release the button.
3. After reset is complete, press and release the **Output Select** button once to view the network status screen on the LCD. The new IP address of the panel will be displayed.

ROUTER CONFIGURATION

This section explains how to set up the panel behind a router and enable remote access to the panel over the Internet.

A router allows multiple PCs to share a single Internet connection. To enable access to the panel over the Internet, you will need to configure your router to forward incoming remote data to the local IP address of your panel.

The following steps use a Linksys WRT54G router as an example.

1. Log in to your router and go to the port forwarding screen. In the Linksys WRT54G, this is located in the **Applications and Gaming** tab. The location of port forwarding may be different on other routers (consult your router manual for instructions).
2. To configure HTTP forwarding, following these steps:
 - a. Enter a unique name in the **Application** field.
 - b. Enter the HTTP port number that the panel is using in the **Start** and **End** fields. If you are using the default panel port settings, the port number is **80**.
 - c. Select **Both** under **Protocol** (TCP and UDP).
 - d. Enter the local IP address of the panel (e.g. 192.168.0.180) in the **IP Address** field. See step 2 of **Web-based Configuration Utility** section to find the actual local IP address of your panel.
 - e. Check **Enable**, and then click on **Save Settings**.

NOTE: Many ISPs block access to port 80. If your ISP does block port 80, you will need to change the HTTP port the panel uses from 80 to something else, such as 8000. Valid port numbers are in the range of 1 – 65535. See the **Network Setup** section for instructions on how to change the panel network ports. You will also need to change the HTTP port number from 80 to something else if your local network already contains another device using port 80 such as another panel or a web server.

Wireless-G Broadband Router WRT54G

Applications & Gaming Setup Wireless Security Access Restrictions Applications & Gaming Administration Status

Port Range Forward Port Triggering DMZ QoS

Port Range Forward

Port Range					
Application	Start	End	Protocol	IP Address	Enable
http	80	to 80	Both	192.168.0.180	<input checked="" type="checkbox"/>
https	443	to 443	Both	192.168.0.180	<input checked="" type="checkbox"/>
udp	9393	to 9393	Both	192.168.0.180	<input checked="" type="checkbox"/>
	0	to 0	Both	192.168.0.0	<input type="checkbox"/>
	0	to 0	Both	192.168.0.0	<input type="checkbox"/>
	0	to 0	Both	192.168.0.0	<input type="checkbox"/>
	0	to 0	Both	192.168.0.0	<input type="checkbox"/>
	0	to 0	Both	192.168.0.0	<input type="checkbox"/>
	0	to 0	Both	192.168.0.0	<input type="checkbox"/>
	0	to 0	Both	192.168.0.0	<input type="checkbox"/>

Port Range Forwarding :
 Certain applications may require to open specific ports in order for it to function correctly. Examples of these applications include servers and certain online games. When a request for a certain port comes in from the Internet, the router will route the data to the computer you specify. Due to security concerns, you may want to limit port forwarding to only those ports you are using, and uncheck the **Enable** checkbox after you are finished.
[More...](#)

CISCO SYSTEMS

Figure 7.

3. To configure HTTPS forwarding, repeat steps 2a – 2e with the HTTPS port number that the panel is using. If you are using the default panel port settings, the HTTPS port number is 443.

4. To set up your router to allow remote panel firmware upgrades, repeat steps 2a – 2e with the UDP port number that the panel is using. If you are using the default panel port settings, the UDP port number is 9393. Firmware upgrades can still be applied locally if this step is skipped.

5. Before you can access the panel over the Internet, you will need to know the WAN IP address of the router, which is assigned by your ISP. With the Linksys WRT54G router, this information is available in the Status tab, listed as IP Address (see Figure 8).

NOTE: If you are using a Dynamic IP address, your WAN IP Address may change from time to time without warning, depending on your ISP. You may want to obtain a Static IP address from your ISP, which will be more convenient to use to access the panel from a remote location. A Static IP address is a fixed IP address that will not change. Alternatively, if a Static IP address is not available, you can use a Dynamic DNS service such as DynDNS.com (see www.dyndns.com).



Figure 8.

6. To access the panel over the Internet, type the WAN IP Address of the router in the location/address field of your browser, followed by a colon and the HTTP port number that the panel is using (e.g. **http://209.123.10.33:8000** for IP Address **209.123.10.33**, Port **8000**).

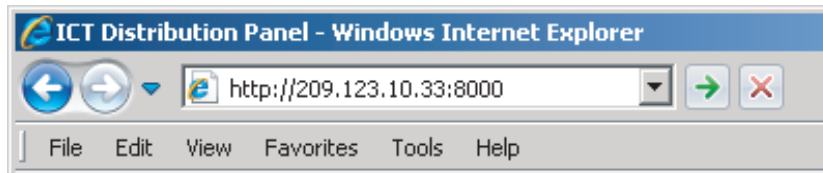

Figure 9.

TEXT MESSAGE ALARM NOTIFICATIONS

The panel can send text message alarm notifications to a cell phone by sending the alarm e-mail to an address at the mobile phone provider. On the **Network Setup** page, enter the address for your phone in one of the “**To**” **E-mail Address** fields. For example, to send a text message to an AT&T phone, enter **cellnumber@txt.att.net**, replacing **cellnumber** with your cell phone number.

Here are some address formats for other mobile phone providers:

AT&T	cellnumber@txt.att.net
Verizon	cellnumber@vtext.com
T-Mobile	cellnumber@tmomail.net
Virgin Mobile	cellnumber@vmobl.com
Nextel	cellnumber@messaging.nextel.com
Bell Mobility	cellnumber@txt.bell.ca
Rogers	cellnumber@pcs.rogers.com
Telus	cellnumber@msg.telus.com

TROUBLESHOOTING

I am unable to access the web-based configuration utility:

- ▶ Check that you are using the correct IP address to access the panel by pressing the **Output Select** button on the front of the panel to view the **Network Status** screen on the LCD. The IP address for the panel may have changed if DHCP is enabled.
- ▶ If the **Network Status** screen on the LCD shows **Network Not Connected**, check the network cable connections to the panel and the network.
- ▶ Ensure that you are using the correct type of network cable. An industry standard "crossover" cable should be used for connecting directly to a computer, and a "straight-through" cable should be used for connecting to a network.
- ▶ Ensure the network card settings on your computer are appropriate for accessing the IP address of the panel. To access a panel with the default IP address of 192.168.0.180, typical network settings for your computer are:
 - o **IP Address:** 192.168.0.100
 - o **Subnet Mask:** 255.255.255.0
 - o **Gateway:** 192.168.0.1
- ▶ If the HTTP port of the panel has been changed, you must append the port number to the URL used to access the panel. See the **Password Reset** section for instructions on how to reset the port number to the default setting.

I forgot my password:

- ▶ See the **Password Reset** section for instructions on how to reset the password.

I am not receiving e-mails from the panel:

- ▶ On the **Network Setup** page, ensure that the **SMTP Server** field is entered correctly. The **SMTP Port** should be set to **25** for most servers.
- ▶ There must be valid e-mail addresses in the **"From" E-mail Address** and **"To" E-mail Address #1** fields. Do not enter more than one e-mail address in each field.
- ▶ If your SMTP server requires authentication, ensure that the **SMTP User Name** and **SMTP Password** fields are entered correctly. If no authentication is required, leave these fields blank.
- ▶ Verify your e-mail settings by going to the **Maintenance** page and clicking on the **Send Test E-mail** button to send a test e-mail. The **Send Test E-mail** page will display an error message if the panel unable to send the e-mail.
- ▶ On the **Alarm Setup** page, ensure that the **Send E-mail** checkbox is checked for alarm conditions you wish to receive notifications for.

PRODUCT SPECIFICATIONS

Operating Voltage:	10 to 30VDC
Panel Capacity:	150A (Continuous) 180A (Peak)
Fuse Capacity:	25A Maximum ATO/ATC Blade x 9 40A Maximum MAXI Blade x 3

Note 1: Ensure that the load total connected to the fused outputs does not exceed the panel capacity rating.

Note 2: Most fuses should be continuously operated at no more than 80% of their nominal current rating.
Consult the fuse manufacturers specifications.

Power Consumption:	2.5 watts
Maximum Cable Length:	100 meters
Voltage Drop (without fuse):	60mV (Typical)
Alarm Contact:	Form “C” Dry Contacts 1A/60VDC Max
Ethernet:	RJ45, 10Base–T
Input Connector:	Heavy Duty Insulated M10 Stud 75in–lbs Max
Output Connector:	Barrier Terminal Block M4 Screws 8 – 20AWG Wire Range 12in–lbs Max
Alarm Connector:	Euro Terminal Block M2 Screws 16 – 28AWG Wire Range 1in–lbs Max
Operating Temperature:	–4°F to 140°F –20°C to +60°C
Dimensions:	19.0” x 9.29” x 1.75” 483mm x 236mm x 45mm
Weight:	8.0lbs 3.6kg
Warranty:	3 years

LIMITED WARRANTY

ICT Ltd. warrants to the original consumer purchaser that this product shall be in good working order, free from defects in materials and workmanship, for a period of three (3) years from the date of purchase. Should failure occur during the above stated time period, then ICT will, at its option, repair or replace this product at no additional charge except as set forth below. All parts, whether for repair or replacement, will be furnished on an exchange basis. All exchange pieces become the property of ICT. This limited warranty shall not apply if the ICT product has been damaged by unreasonable use, accident, negligence, disaster, service, or modification by anyone other than the ICT factory.

Limited warranty service is obtained by delivering the product during the above stated three (3) years warranty period to an authorized ICT dealer or ICT factory and providing proof of purchase date. If this product is delivered by mail, you will insure the product or assume risk of loss or damage in transit, and prepay shipping charges to the factory.

Every reasonable effort has been made to ensure that ICT product manuals and promotional materials accurately describe ICT product specifications and capabilities at the time of publication. However, because of ongoing improvements and updating of ICT products, ICT cannot guarantee the accuracy of printed materials after the date of publication and disclaims liability for changes, errors or omissions.

If this ICT product is not in good working order, as outlined in the above warranty, your sole remedy shall be repair or replacement as provided above. In no event will ICT be liable for any damages resulting from the use of or the inability to use the ICT product, even if an ICT employee or an authorized ICT dealer has been advised of the possibility of such damages, or for any claim by any other party.

ICT reserves the right to make changes without further notice to any products or documentation for improvement of reliability, function, or design.

ICT Ltd. does not recommend use of its products in life support applications wherein a failure or malfunction of the product may directly or indirectly threaten life or cause injury. The user of ICT products, which are to be used in life support applications as described above, assumes all risks of such use and indemnifies ICT against all damages.

INNOVATIVE CIRCUIT TECHNOLOGY LTD.
26921 GLOUCESTER WAY LANGLEY, BRITISH COLUMBIA, CANADA V4W 3Y3
T 604.856.6303 F 604.856.6365 www.ict-power.com

